

Article number: 203502803994NI

Description: E+G Levelling sets GN 350.2-80-39-94-NI

Measures

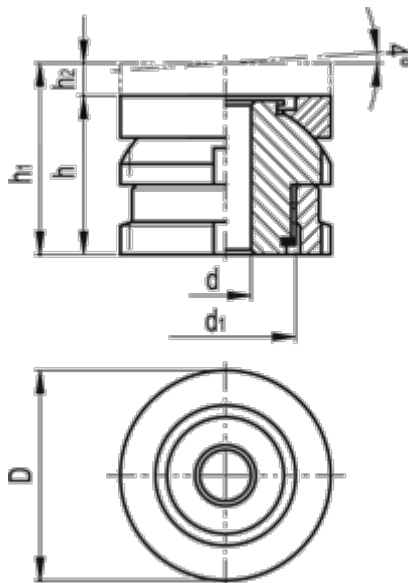

C-spanner DIN 1810 = A80-90

d = 39

D = 80

d_1 = M60x2

For screw = M36

h = 94

h_1 = 144

h_2 = 50

Max static load (kN) = 323

Static preload (kN) = 38.2

Weight (g) = 2560